

NRSA Series

SMD Power Inductors For Automotive

Size 201610



FEATURES

- Magnetic shield type wound inductor for power circuits using a ferrite magnetic material
- High magnetic shield construction and compatible with high-density mounting
- Larger current and lower Rdc were achieved by optimizing the ferrite core figure.
- Operating temperature: -55 to +125°C (including self-temperature rise)
- AEC-Q200 qualified
- Quantity: 2000pcs

APPLICATION

- Car navigation, car stereo and car accessories only

Dimensions: [mm]

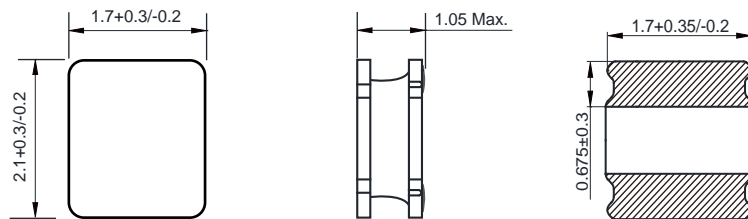

Land Pattern: [mm]

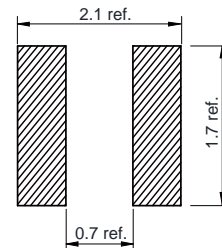

Electrical Properties:

Part Number	Inductance (μH)	Inductance Tolerance (%)	DC Resistance (mΩ)	DC Resistance (mΩ)	Q Factor	Q Factor
NRSA201610-R47N	0.47	±30%	2.16	2.70	41	53
NRSA201610-R68N	0.68	±30%	1.60	2.00		82
NRSA201610-1R0M	1.00	±20%	1.60	2.00	90	115
NRSA201610-1R5M	1.50	±20%	1.36	1.70	137	156
NRSA201610-2R2M	2.20	±20%	1.01	1.26	155	174
NRSA201610-3R3M	3.30	±20%	0.84	1.05	240	294
NRSA201610-4R7M	4.70	±20%	0.68	0.85	340	432
NRSA201610-6R8M	6.80	±20%	0.58	0.72	575	620
NRSA201610-100M	10.0	±20%	0.48	0.60	730	
NRSA201610-150M	15.0	±20%	0.39	0.55	1300	1680
NRSA201610-180M	18.0	±20%	0.32	0.40	1360	1700
NRSA201610-220M	22.0	±20%	0.30	0.38	1550	2000

Saturation Current will cause L to drop approximately 35%

Temperature Rise Current: The actual value of DC current when the temperature rise is $\Delta T=40^{\circ}\text{C}$

Typical Electrical Characteristics:

Soldering Reflow:

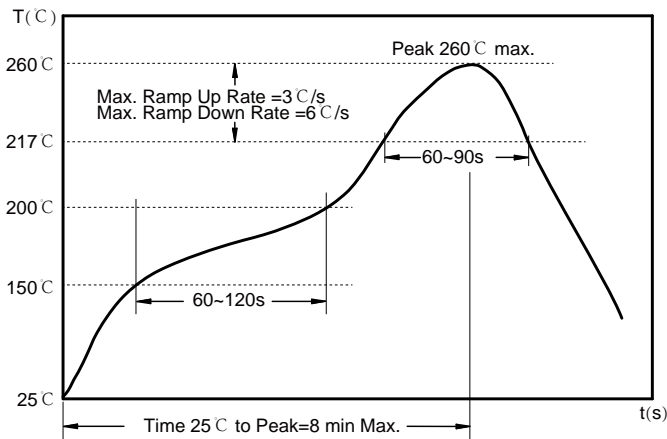

Preheat condition: 150 ~200 °C / 60~120 sec.

Allowed time above 217 °C: 60~90 sec.

Max temperature: 260 °C.

Allowed Reflow time: 2x max.

Packaging Information:

Tape Dimension :

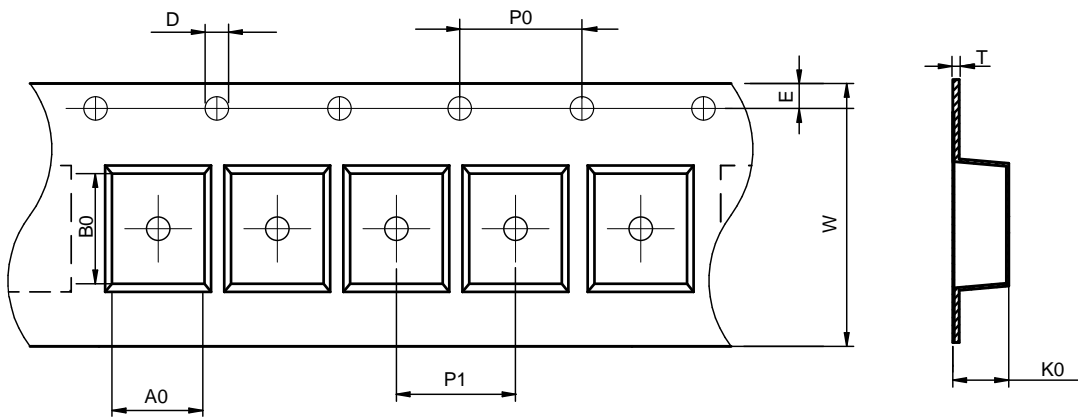

Series	A0 (mm)	B0 (mm)	D (mm)	P0 (mm)	P1 (mm)	W (mm)	K0 (mm)	E (mm)	T (mm)
NRSA201610	1.9±0.05	2.2±0.05	1.5±0.1	4.0±0.1	4.0±0.1	8.0±0.3	1.20±0.05	1.75±0.1	0.25±0.02

Peel force of top cover tape:

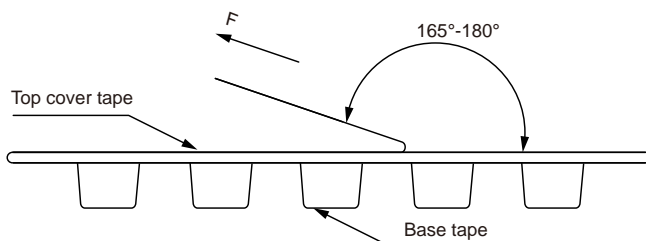

The peel force of top cover tape shall be between 0.2 to 0.58 N

Reel Dimension: [mm]

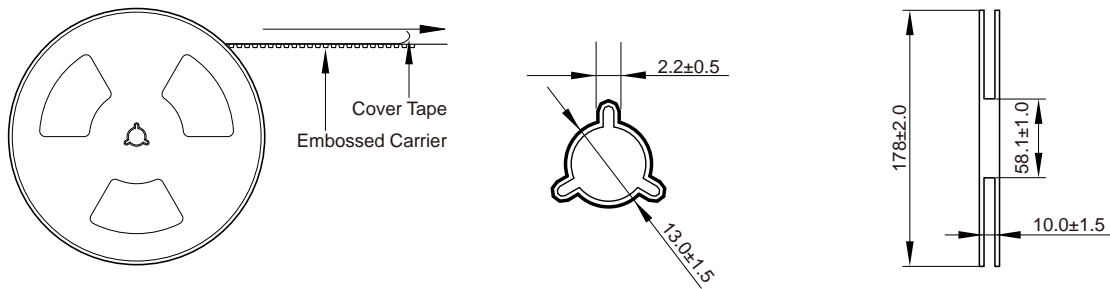

Packaging Quantity:

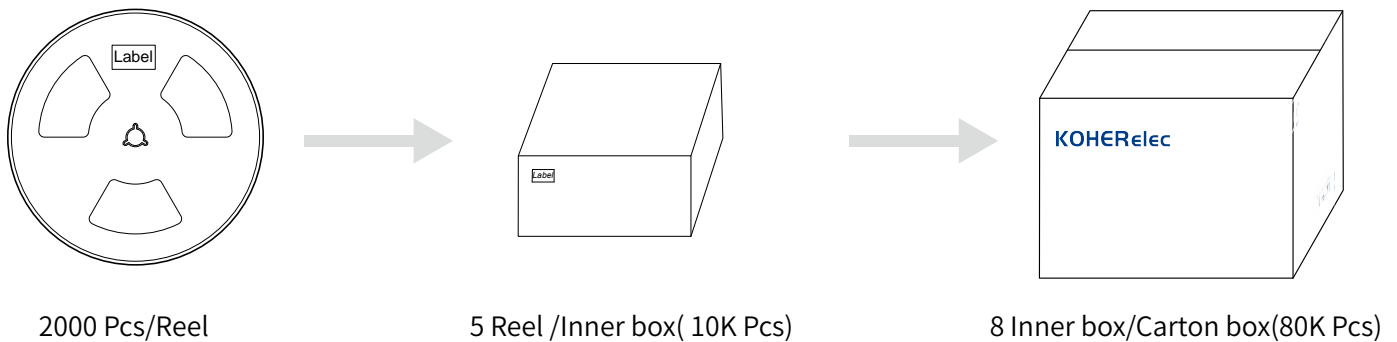

Cautions and Warnings:

Storage Conditions :

- The storage period is within 12 months after the completion of production. Be sure to follow the storage conditions (temperature: -5 to 35°C, humidity: 75% RH Max). If the storage period elapses, the soldering of the terminal electrodes may deteriorate. The warranty period is one year.
- Product should not be exposed to environment with high temperature, high humidity, dust, corrosive gas and etc.
- Products should be handled with care to avoid damage or contamination from perspiration and skin oils.
- Please always handle products carefully to prevent any damage caused by dropping down or inappropriate removing.

Operation Instructions:

- Self heating (temperature increase) occurs when the power is turned ON, so the tolerance should be sufficient for the set thermal design.
- Before soldering, be sure to preheat components. The preheating temperature should be set so that the temperature difference between the solder temperature and chip temperature does not exceed 150°C.
- Soldering corrections after mounting should be within the range of the conditions determined in the specifications. If overheated, a short circuit, performance deterioration, or lifespan shortening may occur.
- Generally, Koher might not be familiar with either customer's specific application or actual requests as customer does. As a result customer shall be responsible for checking and confirming whether Koher product with the performance described in the product specification is suitable for using in customer's particular application or not.