

FBHA Series



FEATURES

- Noise reduction solution for power line.
- Compatibility with large currents, optimal for low power consumption.
- Various frequency characteristics
- Operating temperature: -55 to +150 °C (including self-temperature rise)

APPLICATION

- Power line filter for body controls, and car multimedia etc.



Part No	Z @ 100 MHz (Ω)	Tolerance	R _{DC} (Ω)	I _R (mA)
FBHA0603-260-602R		%	0.01	6000
FBHA0603-300-302R	30	%	0.04	3000
FBHA0603-300-602R	30	%	0.01	6000
FBHA0603-800-302R	80	%	0.04	3000
FBHA0603-101-302R	100	%	0.04	3000
FBHA0603-121-202R	120	%	0.10	2000
FBHA0603-121-302R	120	%	0.04	3000
FBHA0603-151-202R	150	%	0.10	2000
FBHA0603-221-202R	220	%	0.10	2000
FBHA0603-301-102R	300	%	0.20	1000
FBHA0603-331-152R	330	%	0.10	1500
FBHA0603-471-102R	470	%	0.20	1000
FBHA0603-601-102R	600	%	0.20	1000
FBHA0603-102-102R	1000	%	0.20	1000

referring to 40K self-heating above ambient temperature

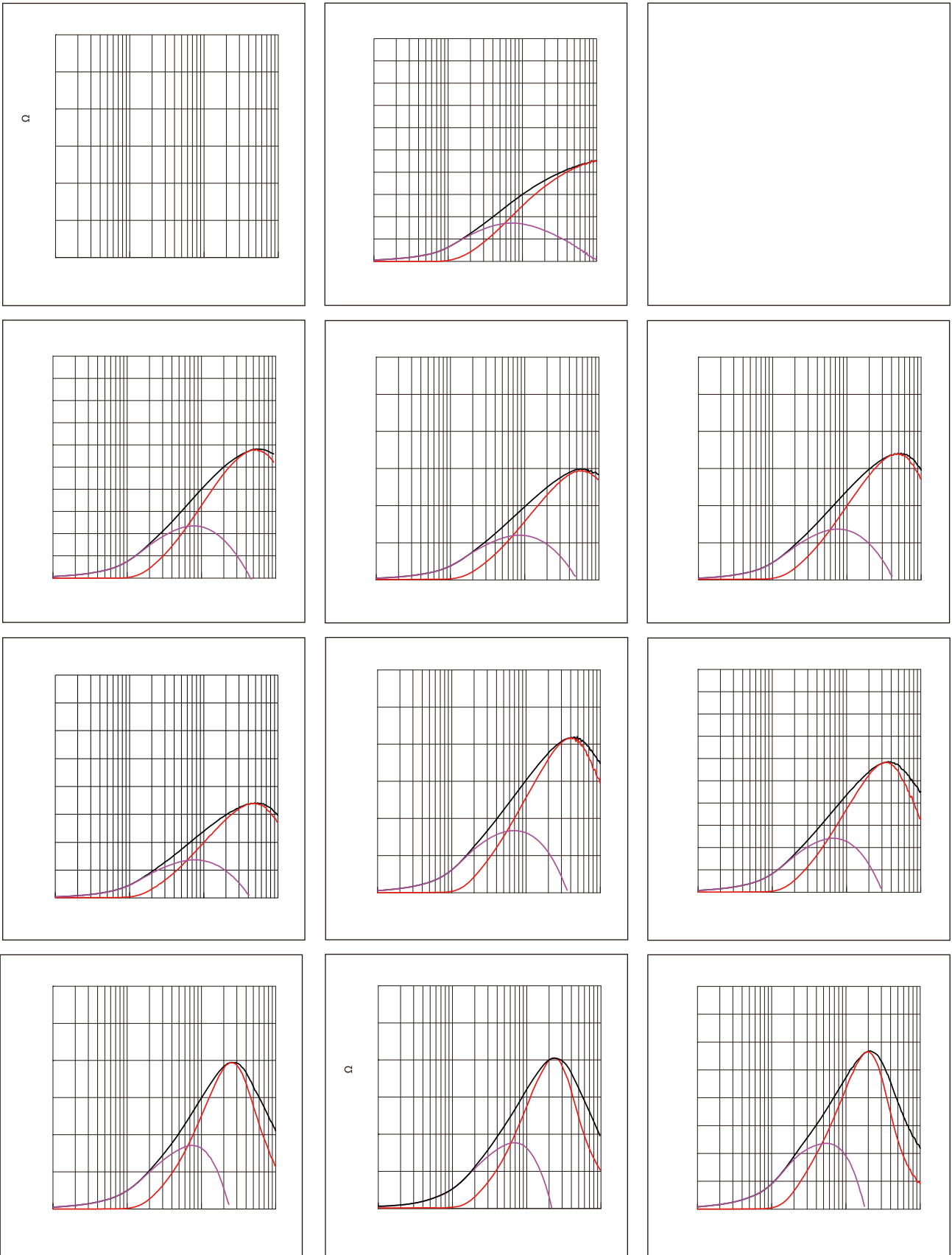

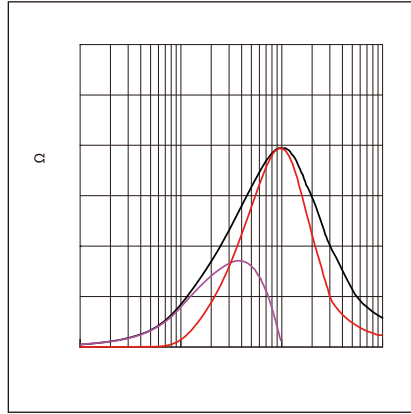
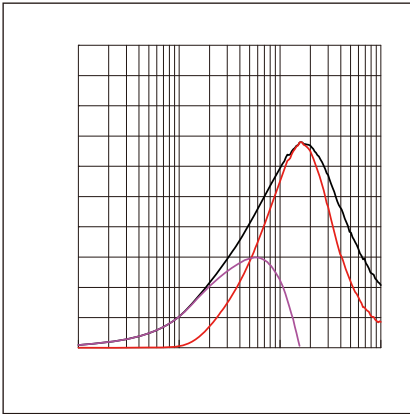

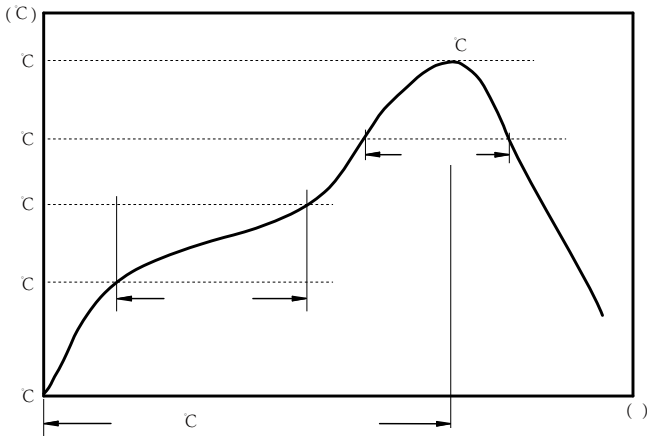

C
C
C

:

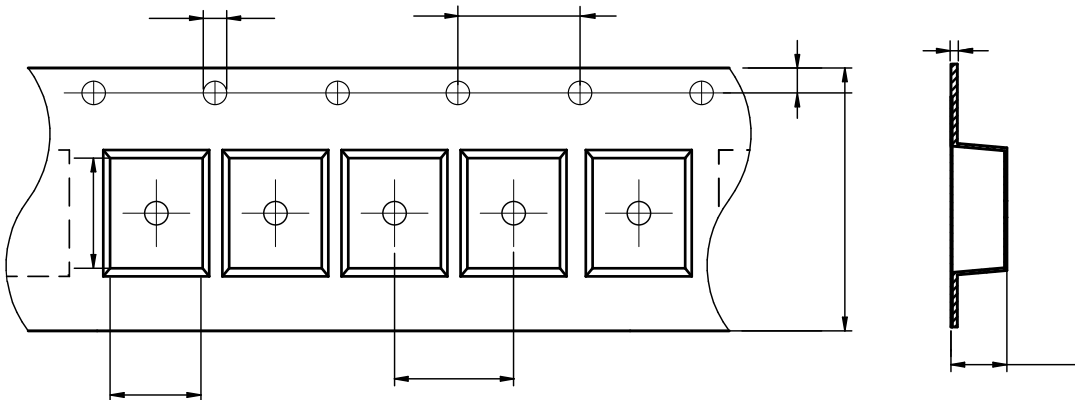

FBHA0603	0.96± 0.05	1.80± 0.05	1.5± 0.1	4.0± 0.1	4.0± 0.1	8.0± 0.3	0.95± 0.05	1.75± 0.1	0.95± 0.05
----------	------------	------------	----------	----------	----------	----------	------------	-----------	------------

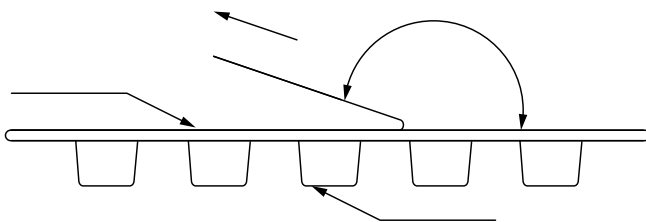

The peel force of top cover tape shall be between 0.14 to 0.58 N



:

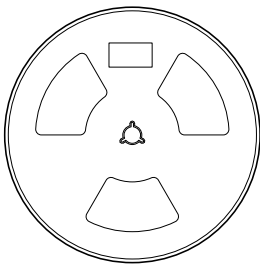
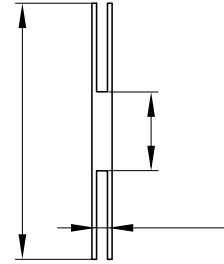
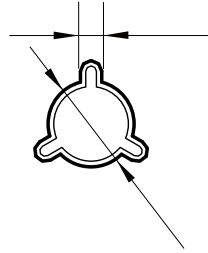
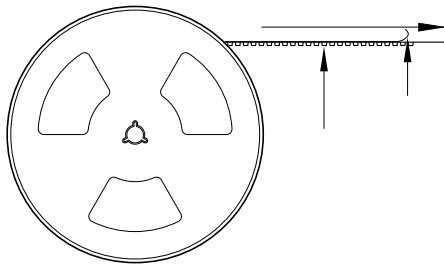

4000 Pcs/Reel

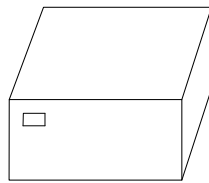

5 Reel /Inner box(20K Pcs)

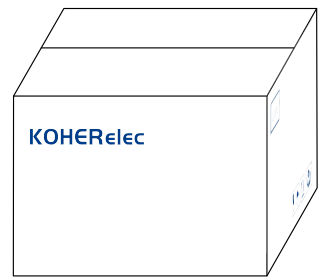

8 Inner box/Carton box(160K Pcs)

:

-
-
-
-
-
-
-
-
-